

# S10AC THRU S10MC

**Surface Mount General Purpose Silicon Rectifiers**  
**Reverse Voltage - 50 to 1000 V**  
**Forward Current - 10 A**

## FEATURES

- For surface mounted applications
- Low profile package
- Glass Passivated Chip Junction
- Easy to pick and place
- Lead free in comply with EU RoHS 2011/65/EU directives

## MECHANICAL DATA

- Case: SMC
- Terminals: Solderable per MIL-STD-750, Method 2026
- Approx. Weight: 0.22g / 0.0077oz

## PINNING

PIN	DESCRIPTION
1	Cathode
2	Anode

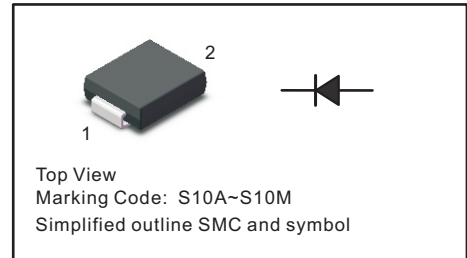

## Maximum Ratings and Electrical characteristics

Ratings at 25 °C ambient temperature unless otherwise specified.

Single phase half-wave 60 Hz, resistive or inductive load, for capacitive load current derate by 20 %.

Parameter	Symbols	S10AC	S10BC	S10DC	S10GC	S10JC	S10KC	S10MC	Units
Maximum Repetitive Peak Reverse Voltage	$V_{RRM}$	50	100	200	400	600	800	1000	V
Maximum RMS voltage	$V_{RMS}$	35	70	140	280	420	560	700	V
Maximum DC Blocking Voltage	$V_{DC}$	50	100	200	400	600	800	1000	V
Maximum Average Forward Rectified Current	$I_{F(AV)}$	10							A
Peak Forward Surge Current 8.3 ms Single Half Sine Wave Superimposed on Rated Load	$I_{FSM}$	200							A
Maximum Instantaneous Forward Voltage at 10A	$V_F$	1.0							V
Maximum DC Reverse Current at Rated DC Blocking Voltage $T_a = 25\text{ °C}$ $T_a = 125\text{ °C}$	$I_R$	5 100							$\mu\text{A}$
Typical Junction Capacitance <sup>(1)</sup>	$C_j$	100							pF
Typical Thermal Resistance <sup>(2)</sup>	$R_{\theta JA}$	10							°C/W
Operating and Storage Temperature Range	$T_j, T_{stg}$	-55 ~ +150							°C

( 1 ) Measured at 1 MHz and applied reverse voltage of 4 V D.C

( 2 ) P.C.B. mounted with 2.0" X 2.0" (5 X 5 cm) copper pad areas.

# S10AC THRU S10MC

**Fig.1 Forward Current Derating Curve**

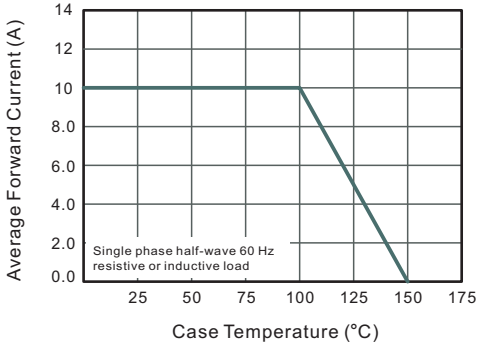

**Fig.2 Typical Reverse Characteristics**

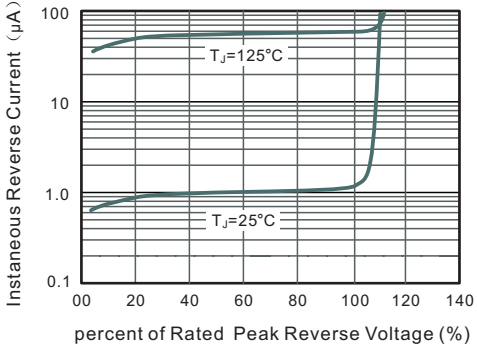

**Fig.3 Typical Forward Characteristic**

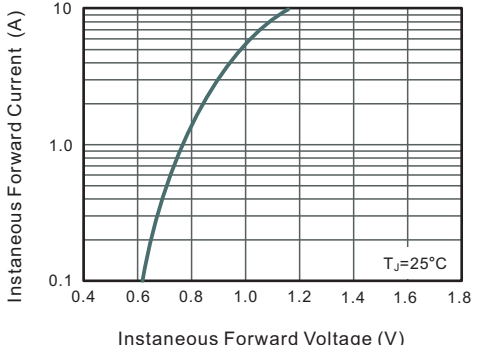

**Fig.4 Typical Junction Capacitance**

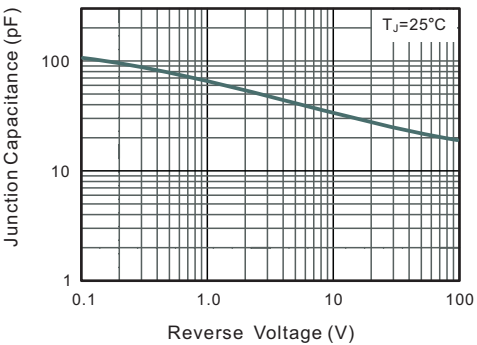

**Fig.6 Maximum Non-Repetitive Peak Forward Surge Current**

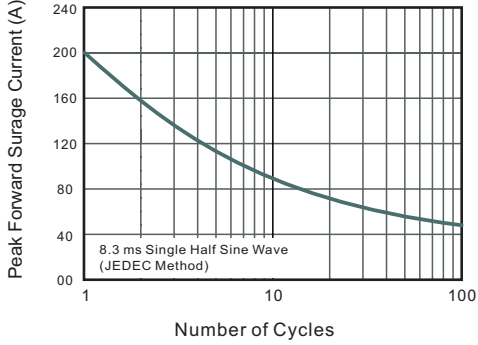

# S10AC THRU S10MC

## PACKAGE OUTLINE

Plastic surface mounted package; 2 leads

SMC

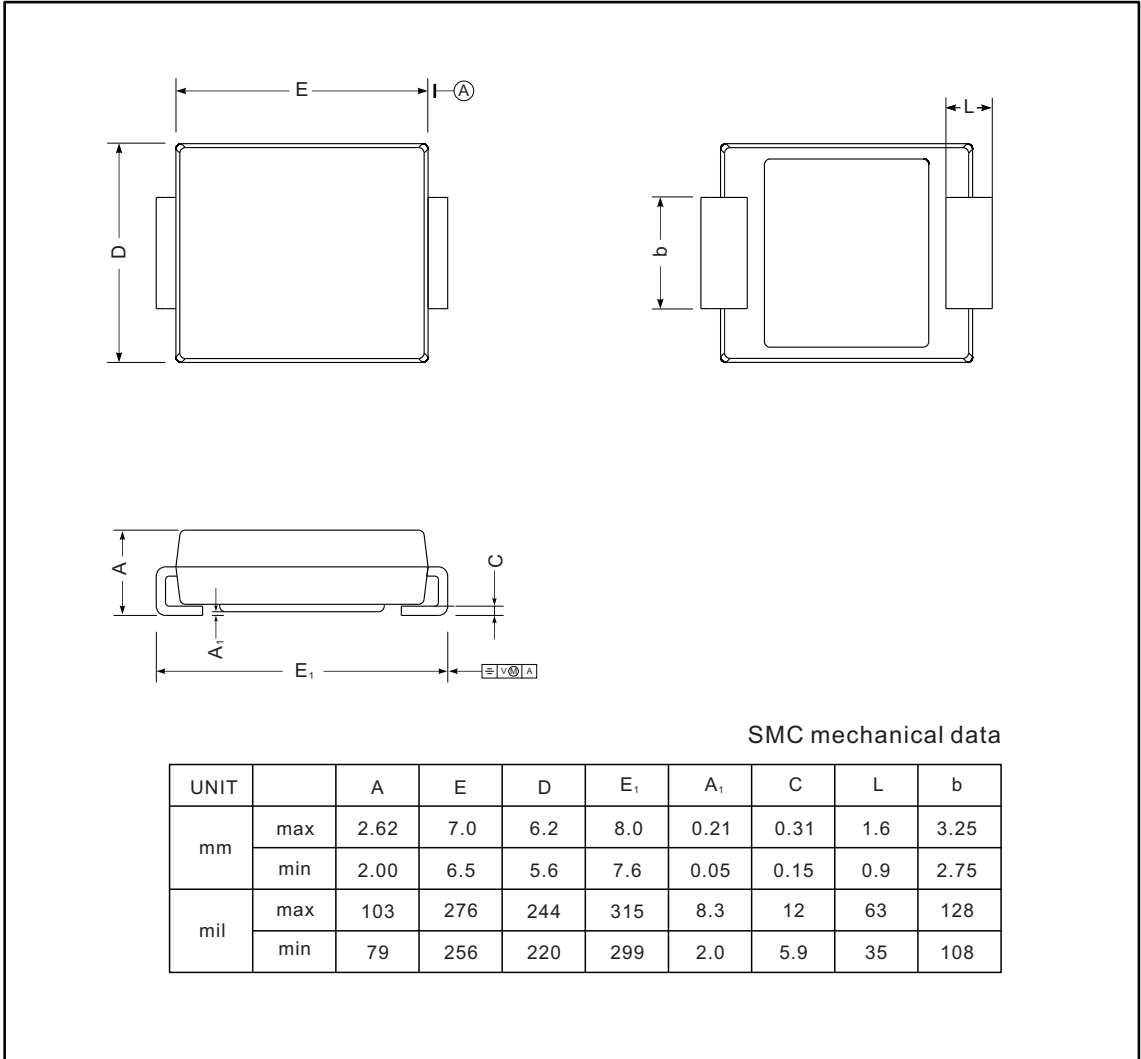

### The recommended mounting pad size

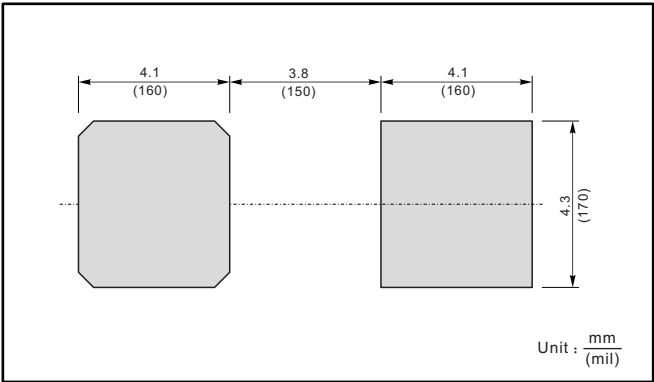

### Marking

Type number	Marking code
S10AC	S10A
S10BC	S10B
S10DC	S10D
S10GC	S10G
S10JC	S10J
S10KC	S10K
S10MC	S10M