

# 1N4001W THRU 1N4007W

## Surface Mount General Purpose Silicon Rectifiers

Reverse Voltage - 50 to 1000 V

Forward Current - 1 A

### FEATURES

- For surface mounted applications
- Low profile package
- Glass Passivated Chip Junction
- Ideal for automated placement
- Lead free in comply with EU RoHS 2011/65/EU directives

### MECHANICAL DATA

- Case: SOD-123FL
- Terminals: Solderable per MIL-STD-750, Method 2026
- Approx. Weight: 15mg / 0.00053oz

### PINNING

PIN	DESCRIPTION
1	Cathode
2	Anode

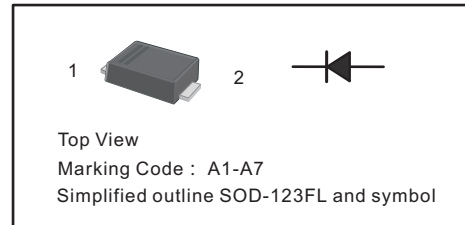

### Maximum Ratings and Electrical characteristics

Ratings at 25 °C ambient temperature unless otherwise specified.

Single phase half-wave 60 Hz, resistive or inductive load, for capacitive load current derate by 20 %.

Parameter	Symbols	1N4001W	1N4002W	1N4003W	1N4004W	1N4005W	1N4006W	1N4007W	Units
Maximum Repetitive Peak Reverse Voltage	$V_{RRM}$	50	100	200	400	600	800	1000	V
Maximum RMS voltage	$V_{RMS}$	35	70	140	280	420	560	700	V
Maximum DC Blocking Voltage	$V_{DC}$	50	100	200	400	600	800	1000	V
Maximum Average Forward Rectified Current at $T_c = 125\text{ °C}$	$I_{F(AV)}$	1							A
Peak Forward Surge Current 8.3 ms Single Half Sine Wave Superimposed on Rated Load	$I_{FSM}$	30							A
Maximum Instantaneous Forward Voltage at 1 A	$V_F$	1.1							V
Maximum DC Reverse Current at Rated DC Blocking Voltage $T_a = 25\text{ °C}$ $T_a = 125\text{ °C}$	$I_R$	5 50							$\mu\text{A}$
Typical Junction Capacitance <sup>(1)</sup>	$C_j$	8(TYP.)							pF
Typical Thermal Resistance <sup>(2)</sup>	$R_{\theta JA}$	90							$^{\circ}\text{C/W}$
Operating and Storage Temperature Range	$T_j, T_{stg}$	-55 ~ +150							$^{\circ}\text{C}$

( 1 ) Measured at 1 MHz and applied reverse voltage of 4 V D.C

( 2 ) P.C.B. mounted with 2.0" X 2.0" (5 X 5 cm) copper pad areas.

# 1N4001W THRU 1N4007W

**Fig.1 Forward Current Derating Curve**

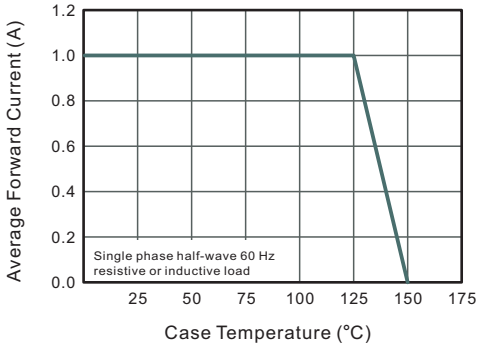

**Fig.2 Typical Instantaneous Reverse Characteristics**

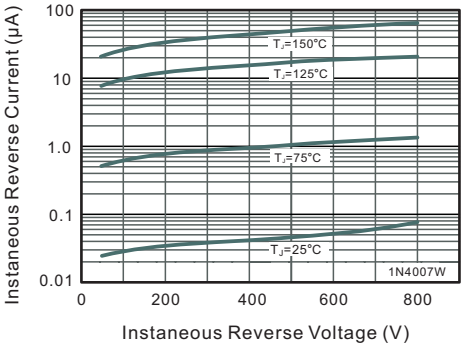

**Fig.3 Typical Forward Characteristic**

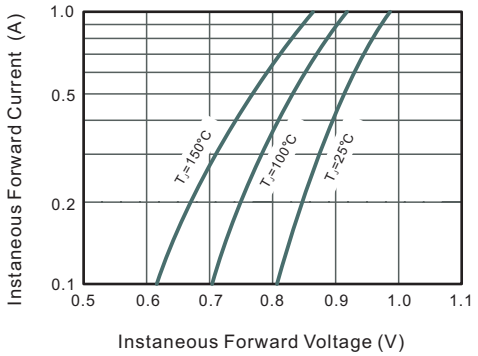

**Fig.4 Typical Junction Capacitance**

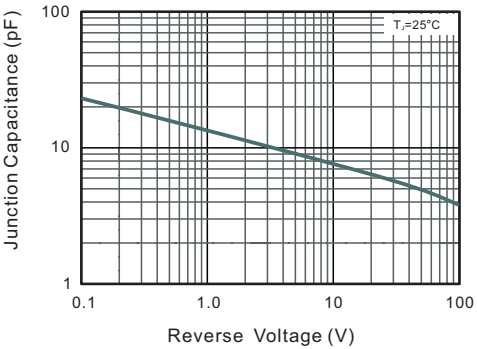

**Fig.5 Maximum Non-Repetitive Peak Forward Surge Current**

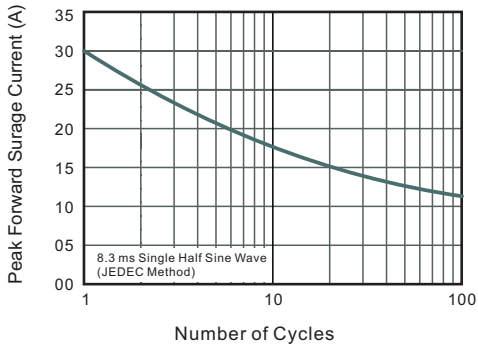

# 1N4001W THRU 1N4007W

## PACKAGE OUTLINE

Plastic surface mounted package; 2 leads

SOD-123FL

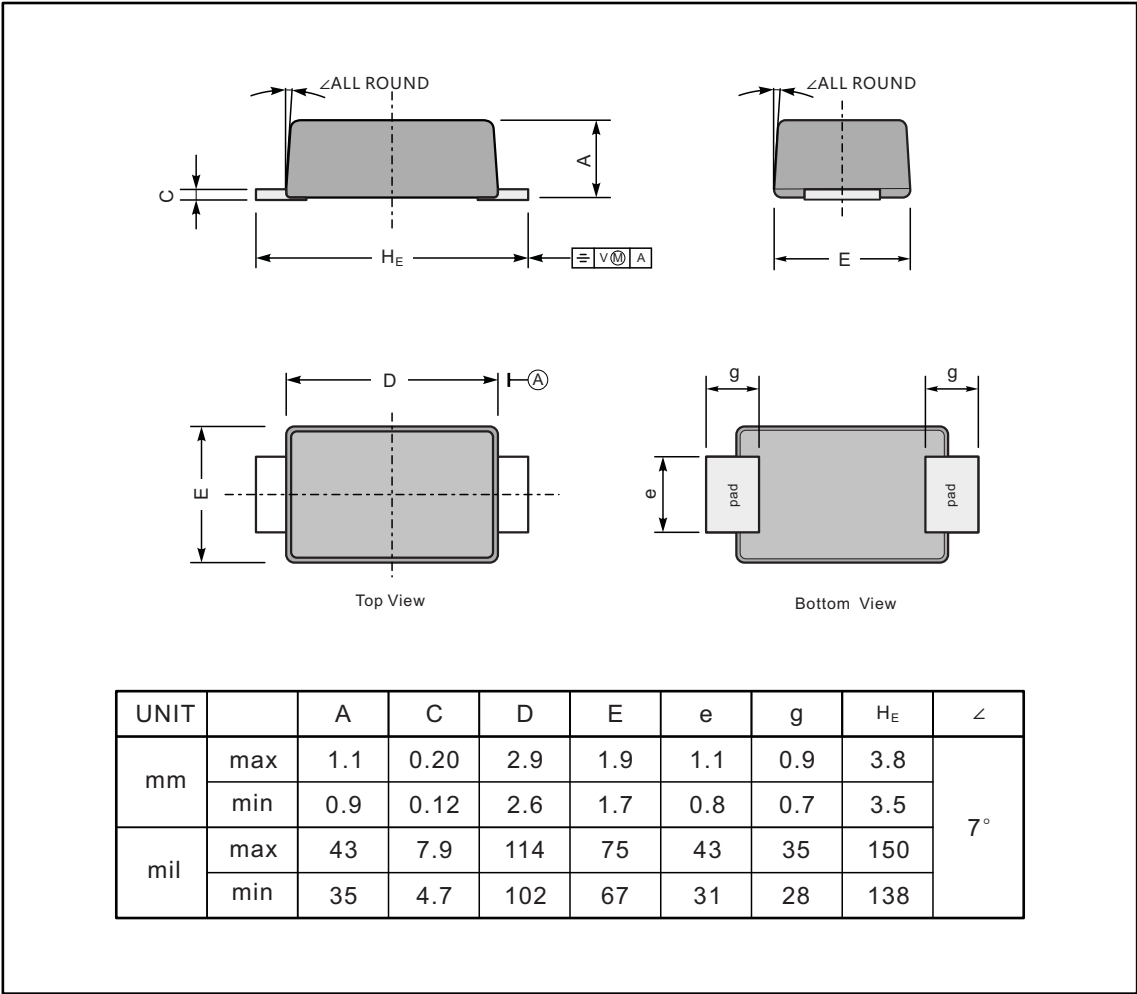

### The recommended mounting pad size

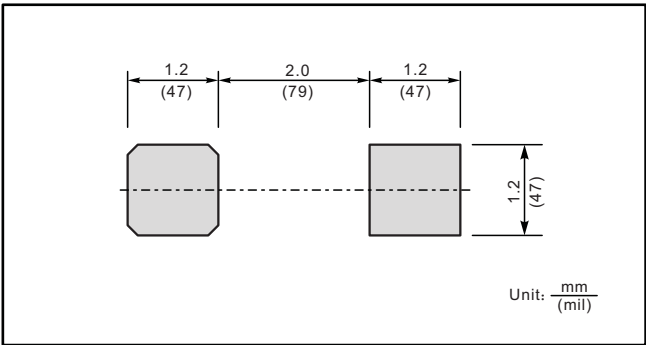

### Marking

Type number	Marking code
1N4001W	A1
1N4002W	A2
1N4003W	A3
1N4004W	A4
1N4005W	A5
1N4006W	A6
1N4007W	A7