

SOT-723 Plastic-Encapsulate MOSFETS

CJ3139K P-Channel MOSFET

$V_{(BR)DSS}$	$R_{DS(on)MAX}$	I_D
-20V	520mΩ@-4.5V	-0.66A
	700mΩ@-2.5V	
	950mΩ(TYP)@-1.8V	

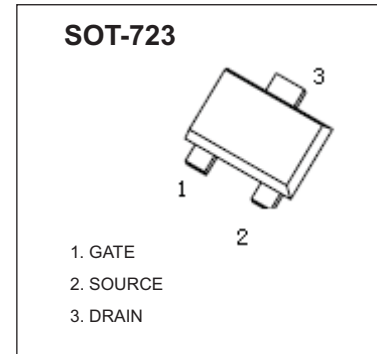

FEATURE

- Lead Free Product is Acquired
- Surface Mount Package
- P-Channel Switch with Low $R_{DS(on)}$
- Operated at Low Logic Level Gate Drive

APPLICATION

- Load/Power Switching
- Interfacing, Logic Switching
- Battery Management for Ultra Small Portable Electronics

MARKING

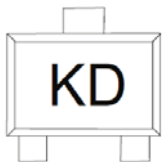

Equivalent Circuit

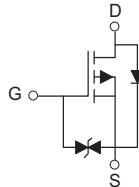

Maximum ratings ($T_a=25^\circ\text{C}$ unless otherwise noted)

Parameter	Symbol	Value	Unit
Drain-Source Voltage	V_{DS}	-20	V
Typical Gate-Source Voltage	V_{GS}	± 12	V
Continuous Drain Current (note 1)	I_D	-0.66	A
Pulsed Drain Current ($t_p=10\ \mu\text{s}$)	I_{DM}	-1.2	A
Power Dissipation (note 1)	P_D	150	mW
Thermal Resistance from Junction to Ambient (note 1)	$R_{\theta JA}$	833	$^\circ\text{C/W}$
Junction Temperature	T_J	150	$^\circ\text{C}$
Storage Temperature	T_{STG}	-55~+150	$^\circ\text{C}$
Lead Temperature for Soldering Purposes(1/8" from case for 10 s)	T_L	260	$^\circ\text{C}$

MOSFET ELECTRICAL CHARACTERISTICS

$T_a=25^\circ\text{C}$ unless otherwise specified

Parameter	Symbol	Test Condition	Min	Typ	Max	Unit
STATIC CHARACTERISTICS						
Drain-source breakdown voltage	$V_{(BR)DSS}$	$V_{GS} = 0V, I_D = -250\mu A$	-20			V
Zero gate voltage drain current	I_{DSS}	$V_{DS} = -20V, V_{GS} = 0V$			-1	μA
Gate-body leakage current	I_{GSS}	$V_{GS} = \pm 10V, V_{DS} = 0V$			± 20	μA
Gate threshold voltage (note 2)	$V_{GS(th)}$	$V_{DS} = V_{GS}, I_D = -250\mu A$	-0.35	-0.45	-1.1	V
Drain-source on-resistance (note 2)	$R_{DS(on)}$	$V_{GS} = -4.5V, I_D = -1A$		430	520	$m\Omega$
		$V_{GS} = -2.5V, I_D = -0.8A$		624	700	$m\Omega$
		$V_{GS} = -1.8V, I_D = -0.5A$		950		$m\Omega$
Forward transconductance (note 2)	g_{FS}	$V_{DS} = -10V, I_D = -0.54A$		1.2		S
Diode forward voltage	V_{SD}	$I_S = -0.5A, V_{GS} = 0V$			-1.2	V
DYNAMIC CHARACTERISTICS (note 4)						
Input capacitance	C_{iss}	$V_{DS} = -16V, V_{GS} = 0V, f = 1MHz$		113	170	pF
Output capacitance	C_{oss}			15	25	pF
Reverse transfer capacitance	C_{rss}			9	15	pF
SWITCHING CHARACTERISTICS (note 4)						
Turn-on delay time (note 3)	$t_{d(on)}$	$V_{GS} = -4.5V, V_{DS} = -10V,$ $I_D = -200mA, R_{GEN} = 10\Omega$		9		ns
Turn-on rise time (note 3)	t_r			5.8		ns
Turn-off delay time (note 3)	$t_{d(off)}$			32.7		ns
Turn-off fall time (note 3)	t_f			20.3		ns

Notes :

1. Surface mounted on FR4 board using the minimum recommended pad size.
2. Pulse Test : Pulse Width=300 μs , Duty Cycle=2%.
3. Switching characteristics are independent of operating junction temperatures.
4. Guaranteed by design, not subject to producing.

Typical Characteristics

Output Characteristics

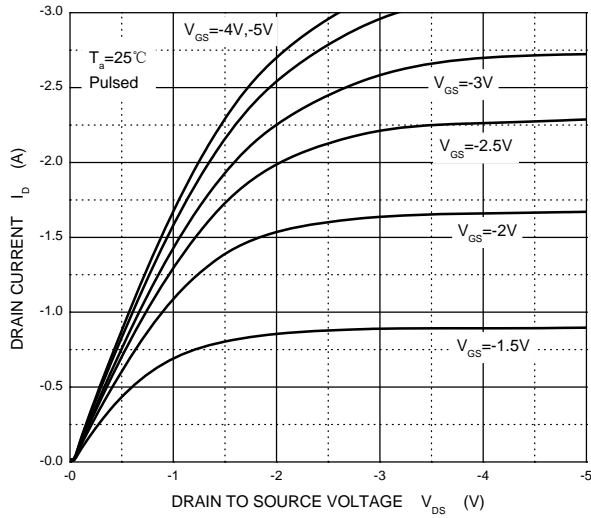

Transfer Characteristics

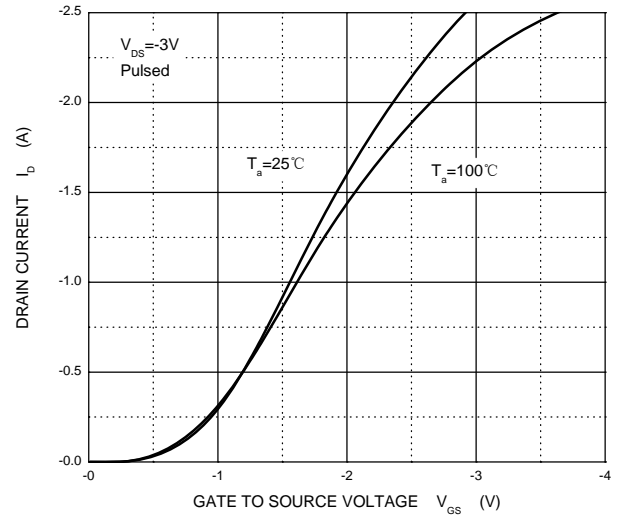

$R_{DS(ON)}$ — I_D

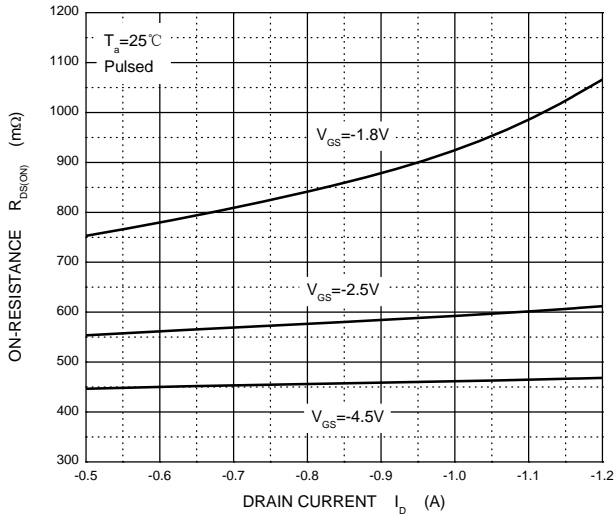

$R_{DS(ON)}$ — V_{GS}

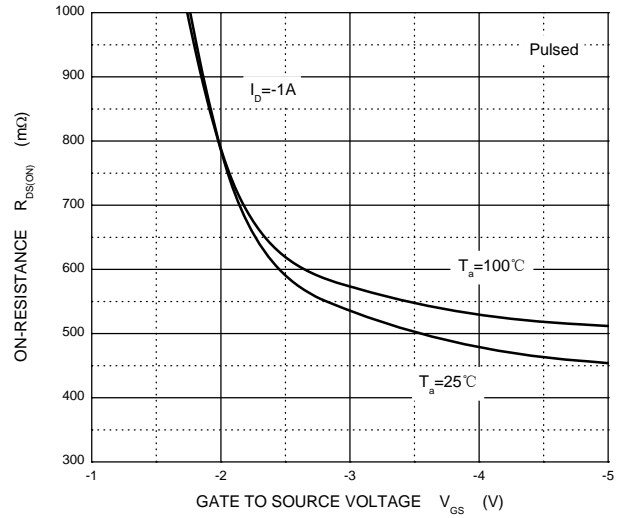

I_S — V_{SD}

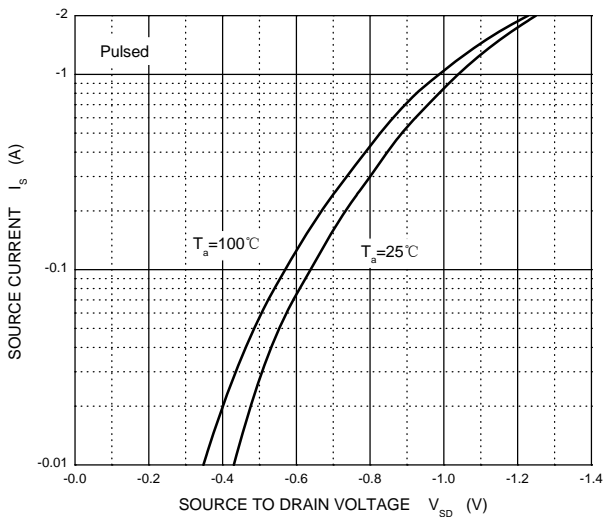

Threshold Voltage

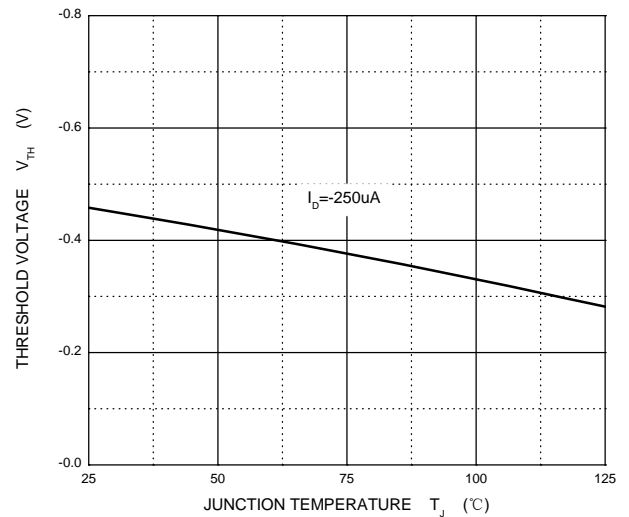

SOT-723 Package Outline Dimensions

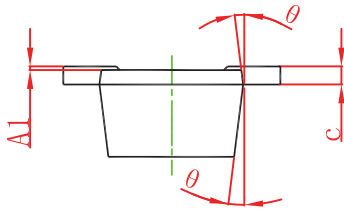
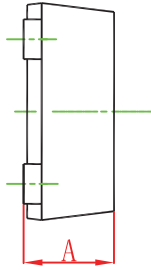
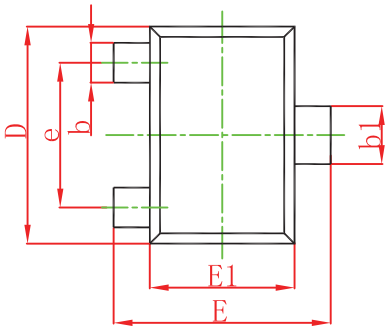

Symbol	Dimensions In Millimeters		Dimensions In Inches	
	Min.	Max.	Min.	Max.
A	0.430	0.500	0.017	0.020
A1	0.000	0.050	0.000	0.002
b	0.170	0.270	0.007	0.011
b1	0.270	0.370	0.011	0.015
c	0.080	0.150	0.003	0.006
D	1.150	1.250	0.045	0.049
E	1.150	1.250	0.045	0.049
E1	0.750	0.850	0.030	0.033
e	0.800TYP.		0.031TYP.	
θ	7° REF.		7° REF.	

SOT-723 Suggested Pad Layout

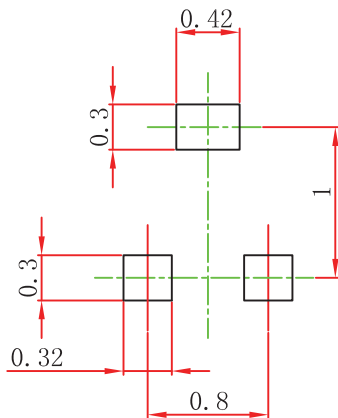

Note:

1. Controlling dimension: in millimeters.
2. General tolerance: $\pm 0.05\text{mm}$.
3. The pad layout is for reference purposes only.

SOT-723 Tape and reel

SOT-723 Embossed Carrier Tape

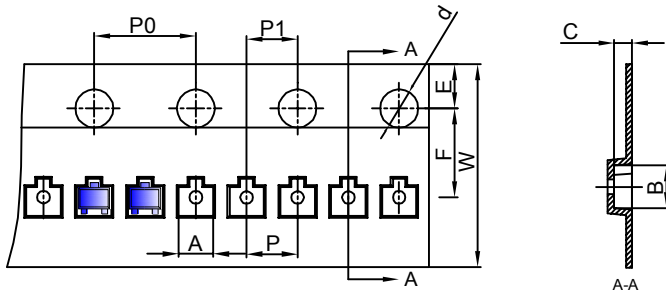

Packaging Description:
 SOT-723 parts are shipped in tape. The carrier tape is made from a dissipative (carbon filled) polycarbonate resin. The cover tape is a multilayer film (Heat Activated Adhesive in nature) primarily composed of polyester film, adhesive layer, sealant, and anti-static sprayed agent. These reeled parts in standard option are shipped with 8,000 units per 7" or 17.8cm diameter reel. The reels are clear in color and is made of polystyrene plastic (anti-static coated).

Dimensions are in millimeter										
Pkg type	A	B	C	d	E	F	P0	P	P1	W
SOT-723	1.33	1.45	0.61	Ø1.50	1.75	3.50	4.00	2.00	2.00	8.00

SOT-723 Tape Leader and Trailer

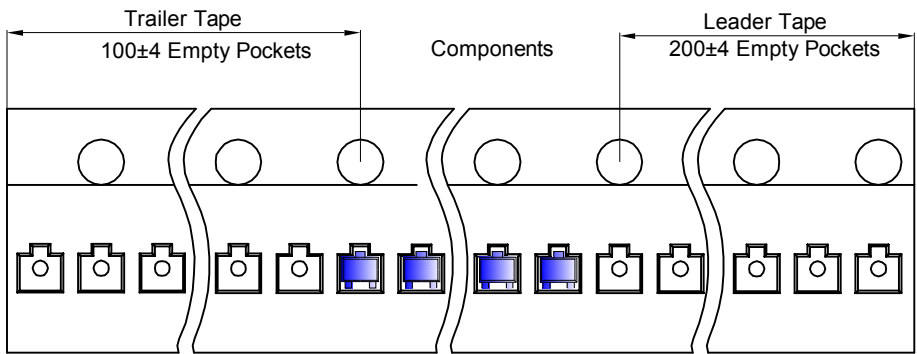

SOT-723 Reel

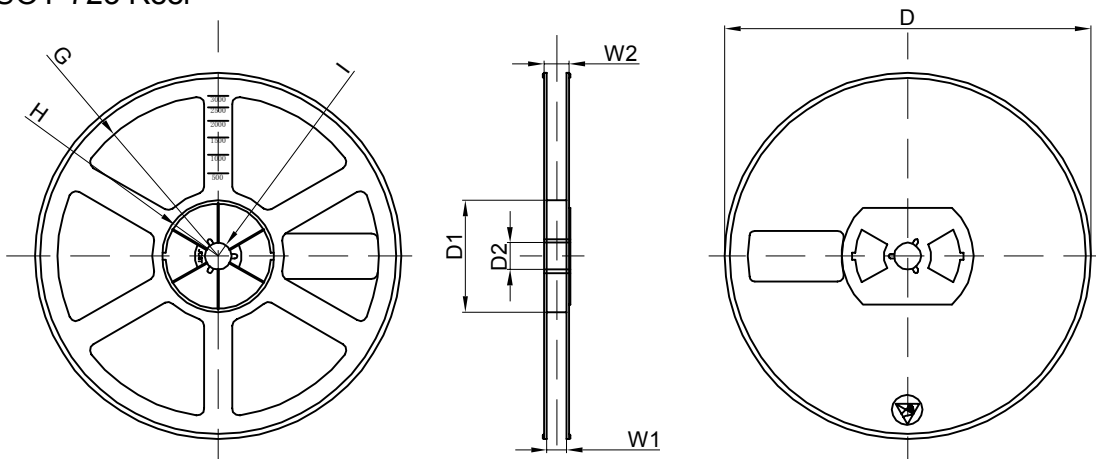

Dimensions are in millimeter								
Reel Option	D	D1	D2	G	H	I	W1	W2
7" Dia	Ø178.00	54.40	13.00	R78.00	R25.60	R6.50	9.50	12.30